



Room Thermostat

RAB21-DC

For two-pipe fan coils with ECM fans

- Room thermostat for heating or cooling
- Automatic changeover function
(with external temperature sensor in heat exchanger)
- Two-position control
- Manual three-speed fan switch
- Supply voltage SELV DC 24 V
- Valve control output signal ON/OFF DC 24 V
- Fan control output signal DC 0 – 10 V

Use

The RAB21-DC room thermostat is used in heating or cooling systems to maintain the selected room temperature.

Typical use:

- Commercial buildings
- Residential buildings
- Light industrial buildings

In conjunction with

- zone valves and thermal valves DC 24 V
- EC fans with control signal DC 0 – 10 V

Functions

The RAB21-DC thermostat is designed to control two-pipe fan coil units with EC fan motors and thermal valve actuators DC 24 V with ON/OFF control signal. Based on the positions of jumpers A and B, the fan speed switch setting and the thermostat contact state, its output terminals provide a control voltage of 0 - 10 V for electronic fan speed control as well as a DC 24 V voltage to control a thermoelectric valve actuator that opens water supply for the exchanger.

By connecting a QAH11.1 temperature sensor to the respective terminals, it is possible to read the temperature of heating or cooling water in the system and to block fan rotation when the water temperature is not sufficient for heating or cooling. When the jumpers are set to the automatic mode position, the water temperature also automatically switches between the heating and cooling mode of the thermostat.

Frost protection

An exchanger frost protection feature is active when a temperature sensor is connected to the thermostat. When the sensor acquires a temperature below 4 °C, a control valve will open regardless of the present operating mode to prevent the freezing of the exchanger. The valve will close again when the temperature reaches 6 °C.

Thermostat mode setting

The thermostat mode is set by changing the position of jumper A located on the top left part of the thermostat printed circuit board and jumper B located on its right side.

Changing the position of the jumpers and connecting the temperature sensor must only be done when the thermostat power supply is disconnected!

Heating

A heating mode is set by moving the jumper A to the rightmost position and leaving the jumper B in the topmost position (position 1). When the thermostat contact closes, a DC 24 V control voltage for valve actuator as well as a control voltage for fan will appear. The voltage will gradually rise from 2 V to the value determined by the selected level of the speed switch. When a temperature sensor is used, the control voltage for fans will not appear until water in the fan coil unit exchanger reaches the desired temperature. When the water temperature drops below the set limit during heating, the control voltage for fan will drop down to zero and will rise again when the water temperature rises to the desired value. The thermoelectric actuator will be still open and allow water to flow through the exchanger. It will close when the thermostat contact opens (after the desired temperature is reached).

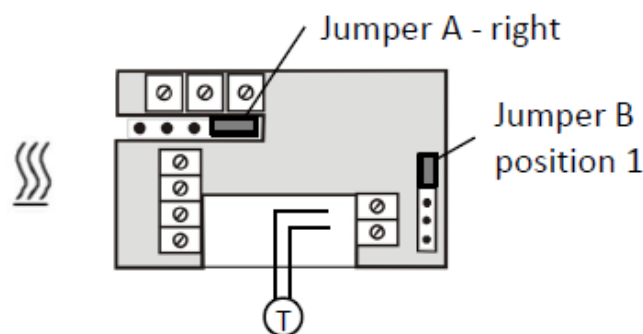

Cooling

The cooling mode is set by moving the jumper A to the middle right position and leaving the jumper B in the topmost position (position 1). Similar to the heating mode, control voltages for valve actuator and fan will appear based on the thermostat contact state. When a temperature sensor is used and the temperature of the cooling water is higher than the desired temperature, the control voltage for fan will have a zero value until the water temperature drops below the set temperature. The thermoelectric actuator will be still open and allow water to flow through the exchanger. It will close when the thermostat contact opens (after the desired temperature is reached).

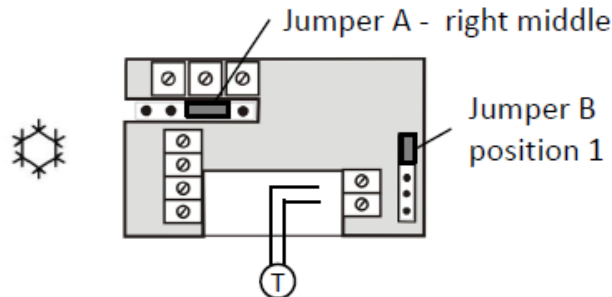

Heating / cooling

When jumper A is moved to the leftmost position and jumper B is moved down by one position (position 2), the automatic mode is set. This mode allows using the thermostat for both heating and cooling. Switchover can be done by remote control or by the temperature of heating/cooling water. When a remote potential-free switch is connected to the terminals for temperature sensor, closing the contact will switch the thermostat to the heating mode and opening to the cooling mode.

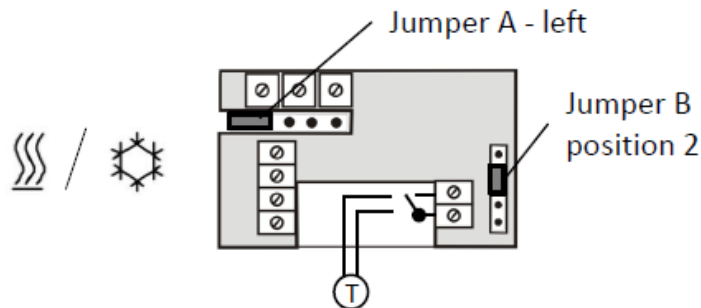

When the QAH11.1 temperature sensor acquiring the water temperature in the exchanger is connected to the terminals the thermostat will switch to a mode determined by the water temperature after the valve is open and the water temperature evaluated. If the water temperature does not reach the desired value for heating or cooling, the original mode is unchanged.

When the thermostat contact is idle for more than 2 hours, an output control voltage for the valve actuator will appear for 3 minutes to allow setting of the appropriate thermostat mode during the transient state between heating and cooling. Then the exchanger water temperature is acquired and if the value warrants the mode change, the thermostat is set to the appropriate mode.

Other parameters of the thermostat

Fan start delay after thermostat contact closing:	2 s (actuator opens, fan starts)
Delay after thermostat opening or speed change:	4 s
Voltage at start-up:	2 V
When the QAH11.1 temperature sensor is connected:	
Water temperature needed for fan turning on – heating:	min. 40 °C
Water temperature for fan turning off – heating:	< 35 °C
Water temperature needed for fan turning on – cooling:	max. 18 °C
Water temperature for fan turning off – cooling:	> 22 °C

Function diagrams

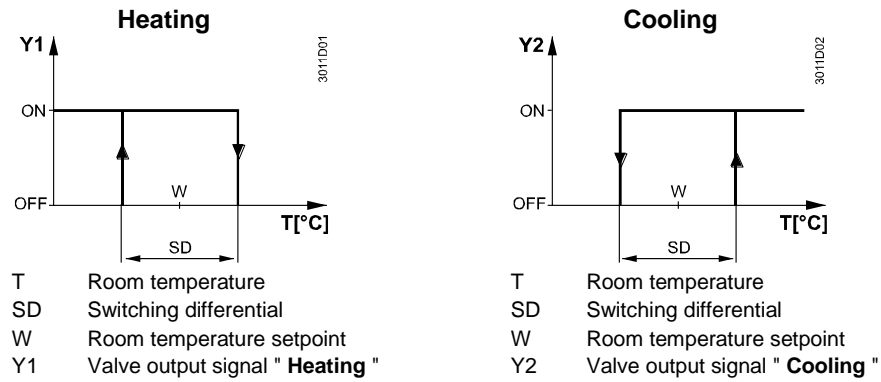

Operating and settings elements

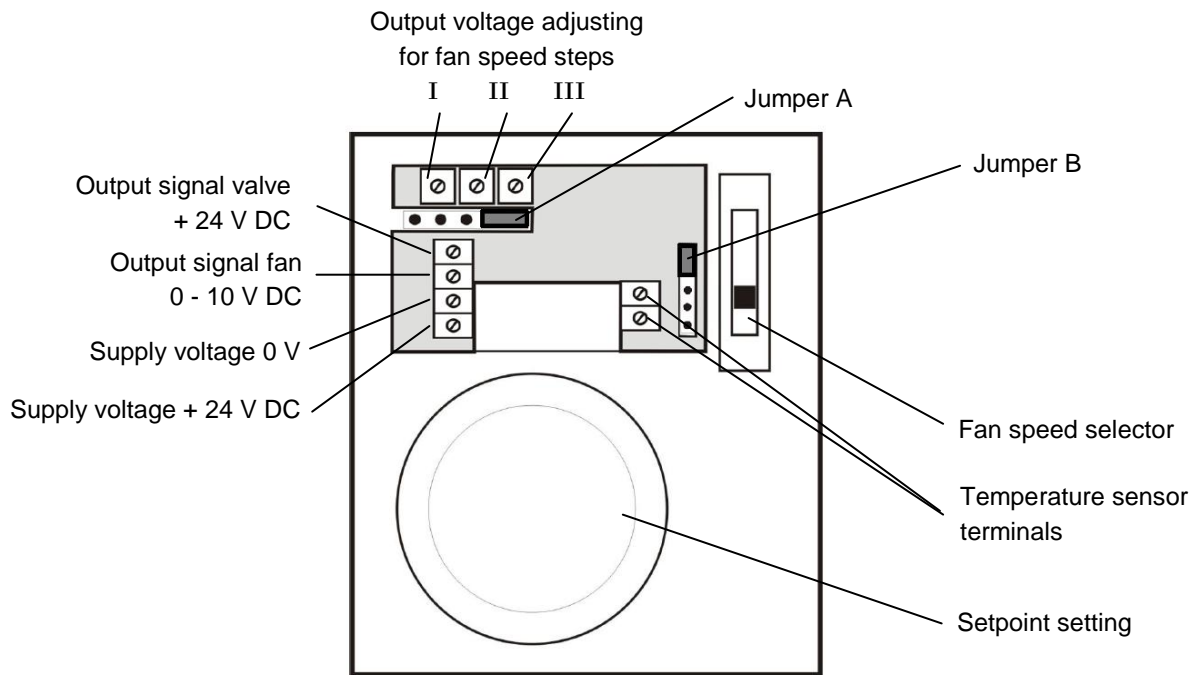

The required temperature can be selected by a setpoint adjuster on the front of thermostat.

The setpoint setting range can be mechanically limited by means of setpoint limiter under the cover.

Fan speed is selected by a slide switch.

Voltages for individual speed levels can be adjusted by trimmers on the top part of the printed circuit board.

Operating mode is selected by changing the positions of jumpers A and B.

Fan control output voltage settings

Control voltage for the fan is determined by its switch position (3 levels) on the thermostat and also by adjusting the trimmers for each individual level.

Low speed: voltage is adjustable from 2 to 6 V

Middle speed: from 6 to 8 V

High speed: from 8 to 10 V

Adjusting the voltage in a speed has no impact on the settings of other speeds.

When the speed switch is moved to another position while the fan is on, there is a delay of 4 s before the control voltage starts increasing or decreasing to the new set value.



The steepness of the voltage change is the same as for the start-up, i.e. about 15 s for a change from 2 V to 10 V.

Type summary

Two-pipe fan coil room thermostat for use with EC fan with DC 0 – 10 V control signal and ON/OFF DC 24 V valve

RAB21-DC

Equipment combinations

Type of unit	Type reference	Data sheet ¹⁾
Thermal actuator 24 V DC (for radiator valve) 	STA73	4884
Thermal actuator 24 V DC (for small valve VVP47.., VXP47..) 	STP73	4884
Cable temperature sensor NTC 3 kOhm (for water temperature acquisition, automatic heating / cooling changeover) 	QAH11.1	1840

¹⁾ The documents can be downloaded from <http://siemens.com/bt/download>.

Accessories

Description	Type reference	Data Sheet
Changeover mounting kit (50 pcs/package) 	ARG86.3	3009

Technical design

Key features of the RAB21-DC fan coil room thermostat:

- Gas-filled diaphragm
- Two-position control of valve actuator DC 24 V
- Fan output signal DC 0 – 10 V

Notes

Mounting, installation and commissioning

The thermostat should be located where the air temperature can be sensed as accurately as possible, without getting adversely affected by direct solar radiation or other heat or refrigeration sources.

Mounting height is about 1.5 m above the floor.

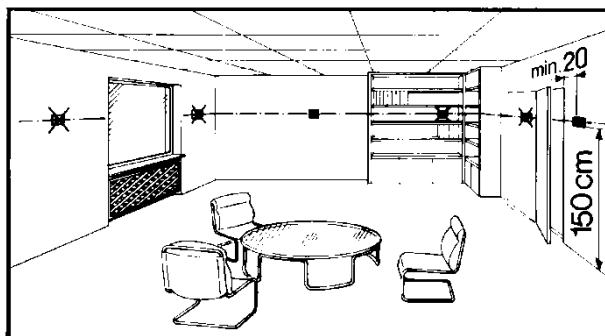

The unit can be fitted to most commercially available recessed conduit boxes or directly on the wall.

Only authorised personnel may open the unit to perform service.

The unit must be isolated from the supply voltage before opening.

When installing the unit, fix the base plate, first then hook on the thermostat body and make the electrical connections. Then fit the cover and secure it (also refer to separate mounting instructions).

The thermostat must be mounted on a flat wall.

The local electrical regulations must be complied with.

If there are thermostatic radiator valves in the reference room, set them to their fully open position.

Thermostat mode setting

The thermostat mode is set by changing the position of jumper A located on the top left part of the thermostat printed circuit board and jumper B located on its right side.

Changing the position of the jumpers and connecting the temperature sensor must only be done when the thermostat power supply is disconnected!

Maintenance

The room thermostat is maintenance-free.

Mechanical design

The diaphragm is filled with environmentally friendly gas.

The thermostat housing is made of plastic.

Ordering

Type (ASN)	Part number (SSN)	Description
RAB21-DC	RAB21-DC	Room thermostat RAB21-DC

Disposal



The devices are considered electronics devices for disposal in term of European Directive 2012/19/EU and may not be disposed of as domestic waste.

- Dispose of the device via the channels provided for this purpose
- Comply with all local and currently applicable laws and regulations.

Technical data

Power supply	Nominal voltage	SELV DC 24 V +/-10%
	Power consumption (without external load)	2 mA
No internal fuse		
External preliminary protection with max. C 10 A circuit breaker in the supply line required under all circumstances		
Valve actuator output	Type	ON/OFF
	Voltage	SELV 24 V DC
	Current	Max. 1 A
Fan output	Type	SELV DC 0 – 10 V
	Output voltage for Low speed	2 V (setting range 2 – 6 V)
	Output voltage for Mid speed	7 V (setting range 6 – 8 V)
	Output voltage for High speed	10 V (setting range 8 – 10 V)
	Current	Max. 10 mA
Sensor input	Type	QAH11.1 (NTC 3 kOhm)
	Temperature range	0 – 49°C
	Cable length	Max. 80 m
	Screw terminals for	2 x 1.5 mm ² (min. 0.5 mm ²)
Operational data	Switching differential SD	≤1 K
	Setpoint setting range	8...30 °C
Environmental conditions	Operation	to IEC 60721-3-3
	Climatic conditions	Class 3K5
	Temperature	0...50 °C
	Humidity	<95 % r.h.
	Pollution degree	normal, to EN 60730-1
	Transport / storage	to IEC 60721-3-2
	Climatic conditions	Class 2K3/1K3
	Temperature	-20...50 °C
Humidity	<95 % r.h.	
Mechanical conditions	Class 2M2	
Standards	EMC	EN 55014-2:15
	Immunity, emission	EN 55014-1:06+A1:09+A2:11
	CE Conformity EMC directive	2014/30/EC
	Safety standard	II to EN 60730-1
	Degree of protection of housing	IP30 to EN 60529
Environmental compatibility	The product environmental declaration CE1EC316 contains data on environmentally compatible product design and assessments (RoHS compliance, materials composition, packaging, environmental benefit, disposal).	
Mechanical design	Weight	0.14 kg
	Colour	white, NCS S 0502-G (RAL 9003)

Připojovací svorky

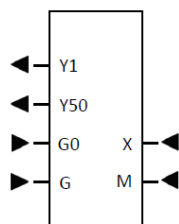

G	Supply voltage + DC 24 V SELV
G0	Supply voltage 0 V
Y1	Control output "Valve" DC 24 V
Y50	Control output „Fan“ DC 0...10 V
X	Multifunctional input for temperature sensor (QAH11.1) or potential-free contact (Heating / Cooling changeover)
M	Measuring neutral for sensor or contact

Connection diagrams

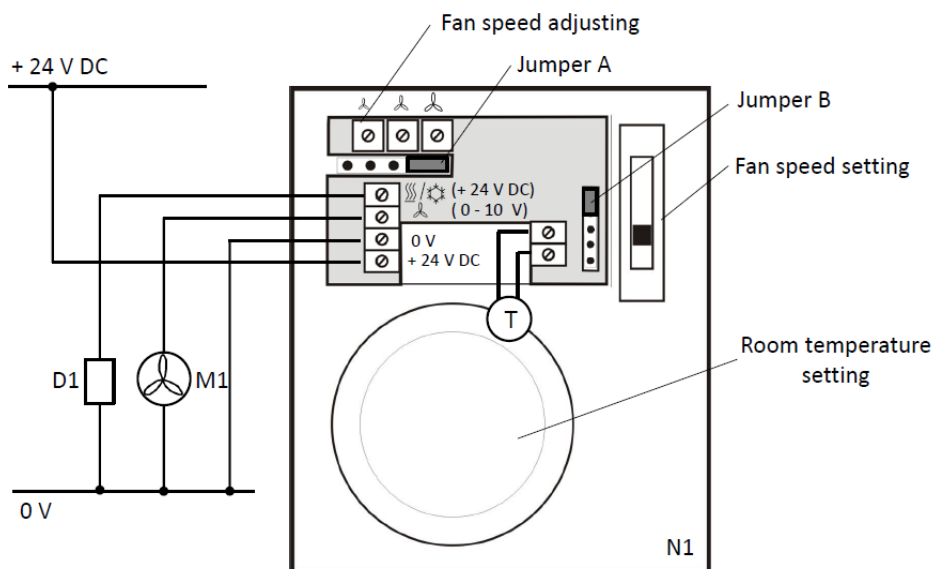

- +24 V DC; 0 V Supply voltage SELV DC 24 V
 D1 Zone valve or thermal actuator for heating or cooling 24 V DC
 M1 EC fan with control signal DC 0 – 10 V
 N1 Room thermostat RAB21-DC
 T Temperature sensor QAH11.1

Dimensions

Room thermostat

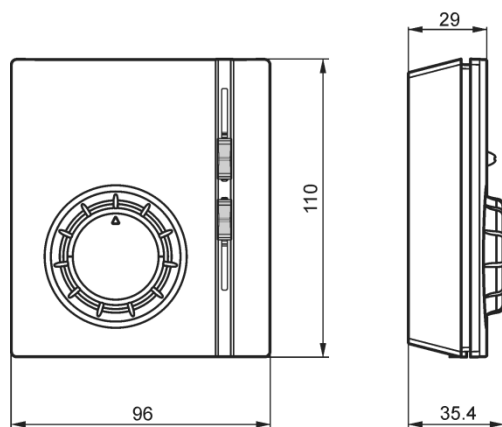

Base plate

